

# CONTENTS

## Page

KERBS .....	1
ETHEKWINI PRODUCTS .....	2
ETHEKWINI PRODUCTS .....	3
WATER CHANNELS .....	4
WATER CHANNELS / GRILL BLOCKS / CHANNEL DRAIN COVERS .....	5
STADIUM SEATING / ETHEKWINI & TELKOM SPEC PRODUCTS .....	6
PRECAST PANELS .....	7
DURBAN BEACHFRONT (KERBS) .....	8
WARWICK (BARRIER KERBS & REINFORCED EARTH) / M41 (KERBS) .....	9
TOWN GARDENS (SEATING) .....	10
WASH TROUGHS / WALL CAPPING .....	11
PAVING SLAB / GRASS BLOCKS .....	12
SILLS A .....	13
SILLS B .....	14
SILLS C .....	15
GULLEYS / SEPTIC TANK .....	16
TERRA CLASS .....	17

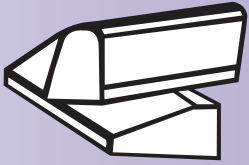

## Kerbs

As per Ethekweni Spec

All products must comply with the following:

- 1) Free from cracks other than hair line cracks;
- 2) Free from visible twist and dents;
- 3) No patching of defective surfaces or edges;
- 4) The colour of the product should be uniform.
- 5) Arrises must be truly formed

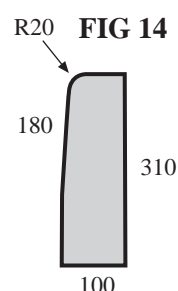
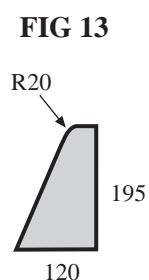
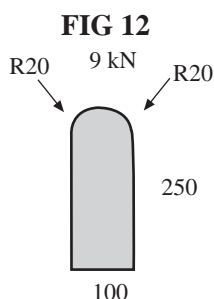
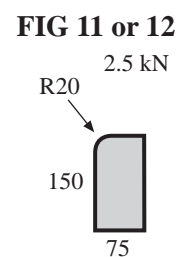
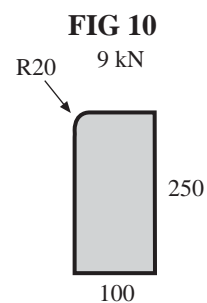
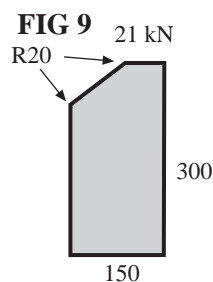
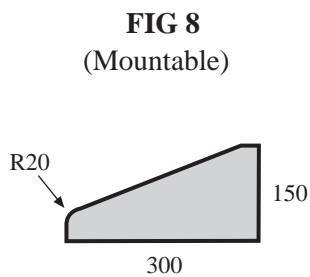
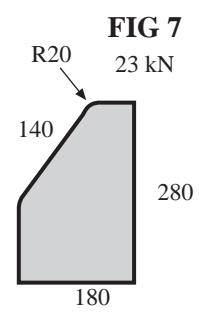
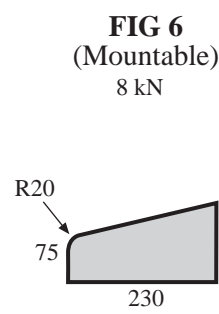
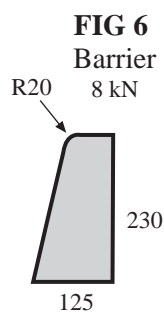
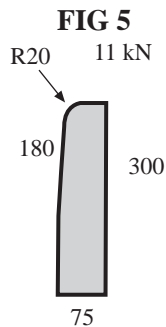
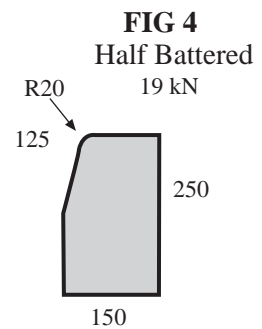
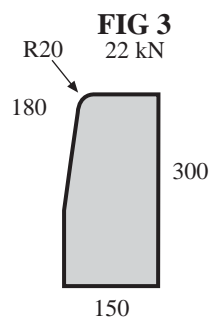
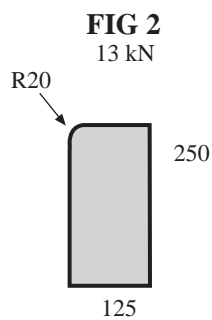
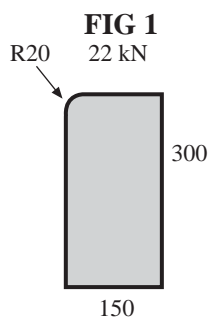

**Mini  
Kerb 80**

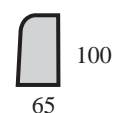

**Tapered Mini Kerb**

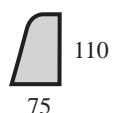

Kerbs are available in 1/3's and 1 metre

NOTE: The tolerance of longitudinal and radial dimensions is  $\pm 3$ mm.

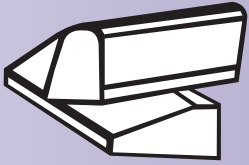

# KALVIS CC

PRECAST CONCRETE SPECIALIST

## Kerbs

As per Ethekweni Spec

**FIG 13**  
Rectangular  
13 kN

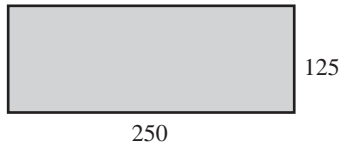

**FIG 14**  
Tapered  
11 kN

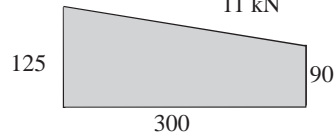

## Ethekweni Products

As per ETHEKWINI Specification

Available L/D x 100 H/D x 150

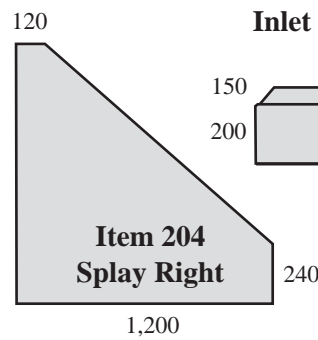
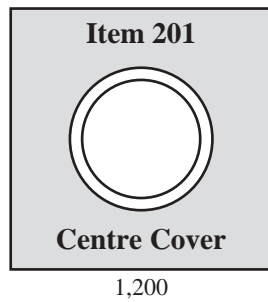
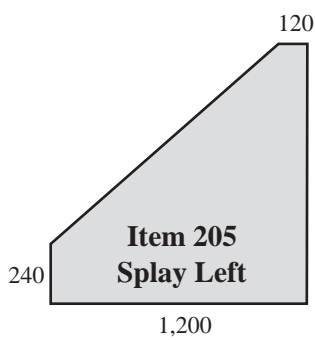

**Inlet Support Beam Item 203**

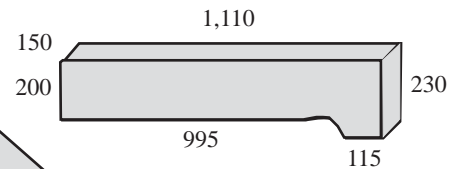

### Guard Rail Post

Single Head 300 mm  
Single Head 400 mm

Double Head 300 mm  
Double Head 400 mm

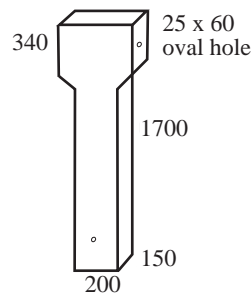
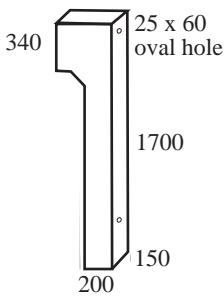

### PARKING METER HANDRAIL POST

#### BASE

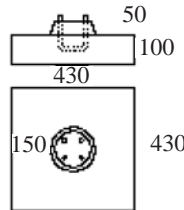

#### Rodding Cover



750 x dia x 100  
with 2m galvanised wire

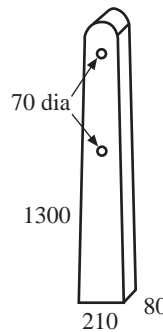

### METRO BOLLARD ITEM 212



250

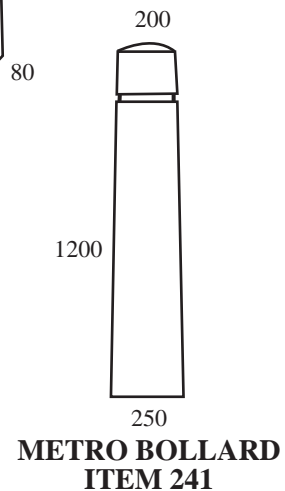

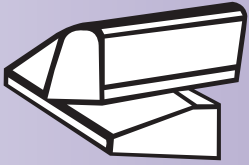

## Ethekwini Products

As per ETHEKWINI Specification

**Cable Marker**

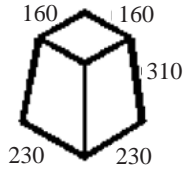

**Valve Marker Post**

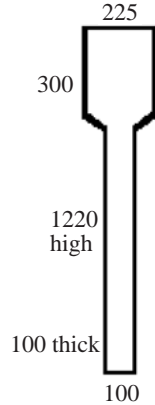

**T Marker**

- V - valve
- W - water
- F - fire
- SV - scorer valve

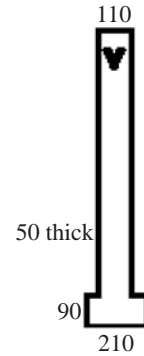

**E D Slabs**

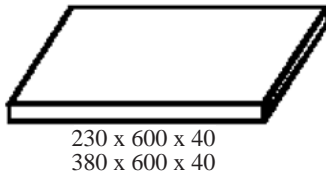

**Cable Marker**

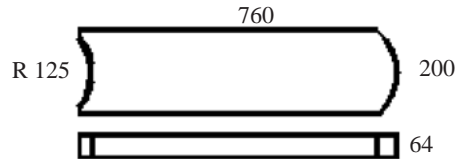

**Pipeline Marker Post**

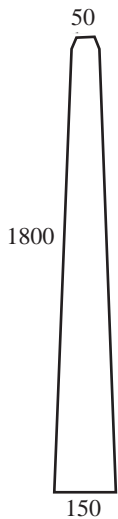

12mm chamfer



**ETHEKWINI LOUVER VENT BLOCK**

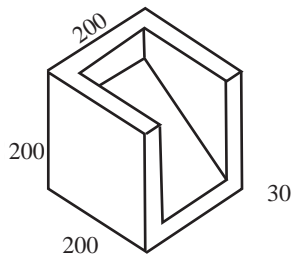

**VALVE CHAMBER STD RECTANGULAR**

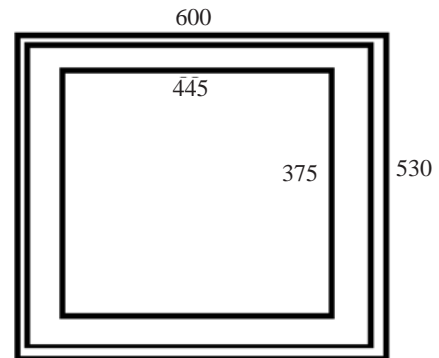

**VALVE SPACER RING**

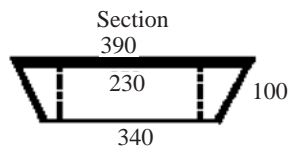

Section

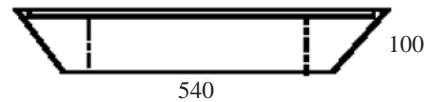

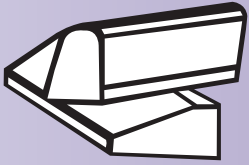

## Water Channels

**TYPE 01**  
x 1000mm

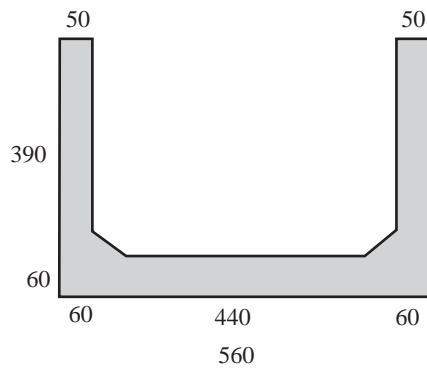

**TYPE 02**  
x 500mm

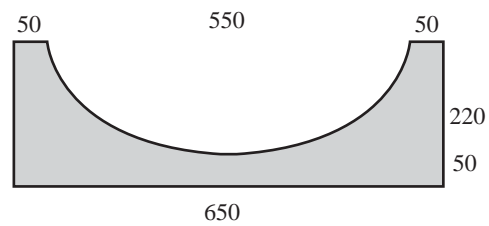

**TYPE 03**  
13 x 1000mm

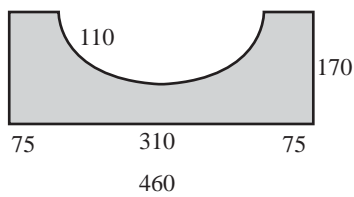

**TYPE 04**  
14 x 1000mm

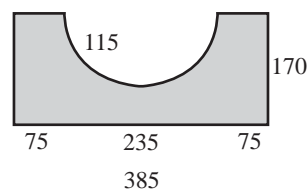

**DRIVEWAY TYPE 15**  
with rebate for  
galv. steel grating

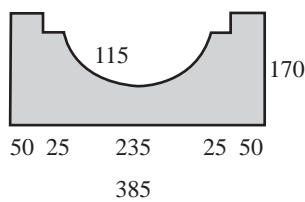

**TYPE 05 x 1000mm**

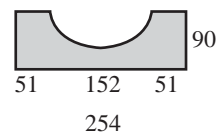

**TYPE**  
16 x 1000mm

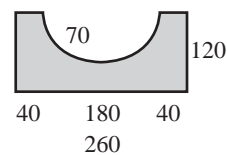

**DRIVEWAY**  
**TYPE 16**

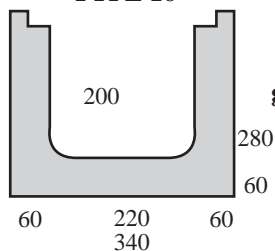

with rebate for  
galv. steel grating



**GALV STEEL GRATING**  
FOR TYPE 15 & 16

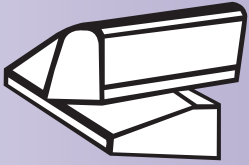

## Water Channels

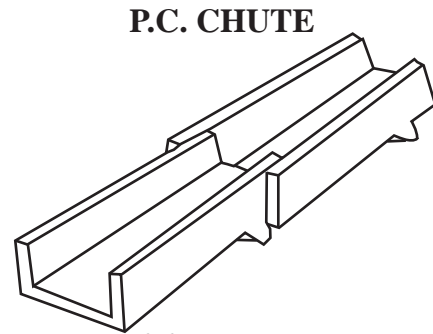
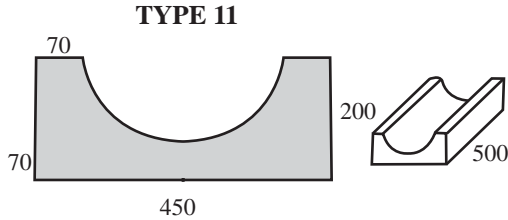

## Grill Blocks

Orders for non standard sizes welcome for any quantity

**Grill Blocks**

- 150 x 150 x 150
- 315 x 150 x 115
- 150 x 150 x 110
- 190 x 190 x 190
- 230 x 230 x 150
- 285 x 285 x 110
- 203 x 203 x 110
- 295 x 295 x 110

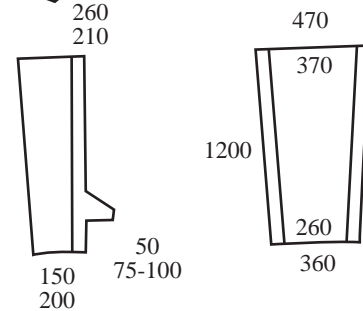
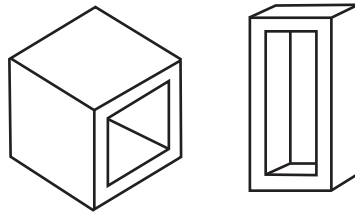

## Channel Drain Covers

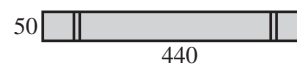
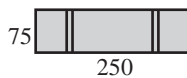
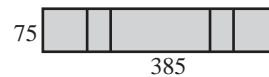
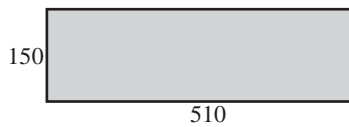
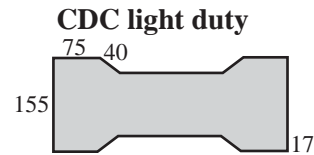
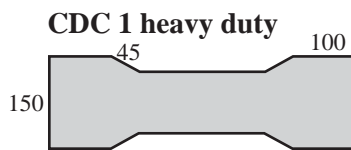

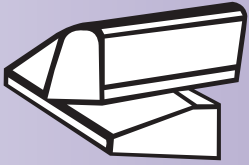

# KALVIS CC

PRECAST CONCRETE SPECIALIST

**Flat Seating**  
605



**Pavilion Seating**

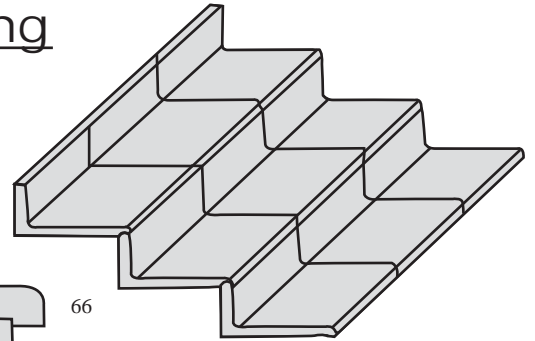

**L. Shaped Seating**

Length of seat 600mm

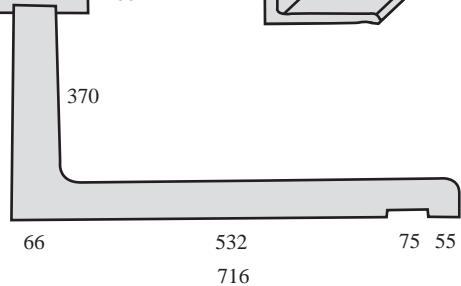

**Manhole shaft/chamber and covers**

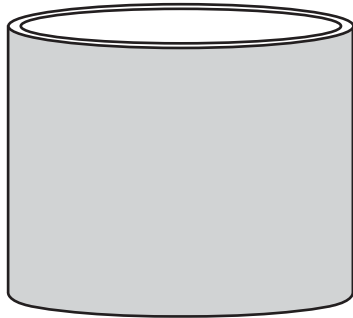

Covers and lids  
in light and heavy duty

- Manhole Shaft
- 750 dia x 500
- 750 dia x 250
- 1000 dia x 500
- 1000 dia x 250



**Ethekwini & Telkom Spec. Products**

**TELKOM COVER**

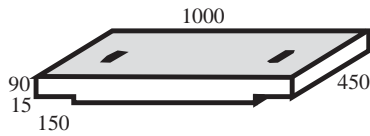

**ETHEKWINI ACCESS SLAB**

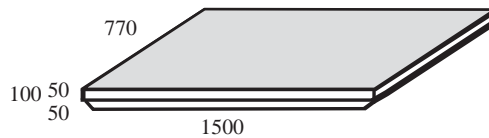

**ETHEKWINI BARRIER DOUBLE SIDED**

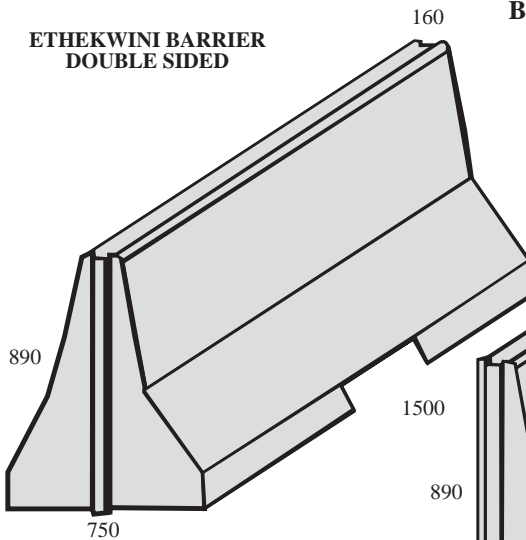

**BARRIERS**

**ETHEKWINI BARRIER SINGLE SIDED**

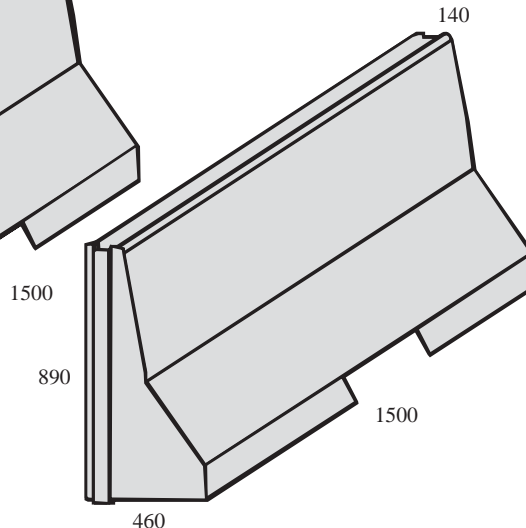

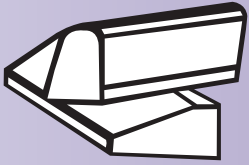

## Wash Troughs

**DOUBLE**

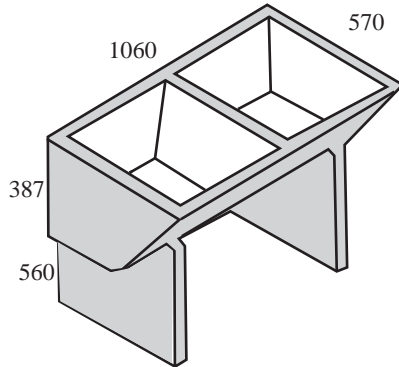

**SINGLE**

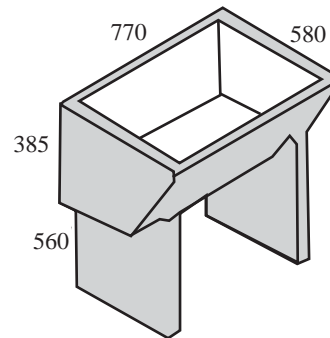

## Wall Capping

**WC 1**

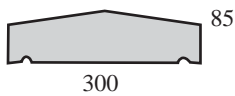

**WC 2**

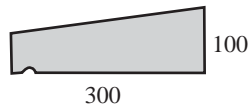

**WC 3**

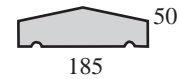

**WC 4**

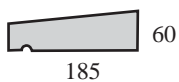

**WC 5**

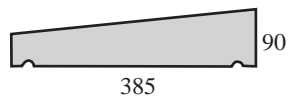

**WC 6**

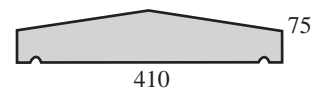

## **Square/Capping**

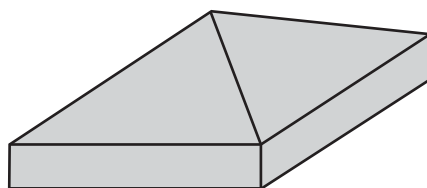

### Standard Sizes

349 x 350 x 138

449 x 450 x 138

549 x 550 x 198

649 x 650 x 118

Special size can be  
made to order



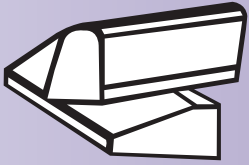

## Pedestrian Paving Slabs

### Finishes

#### Non slip

### Size

**500 x 500 x 50**  
**450 x 450 x 50**  
**610 x 610 x 50**

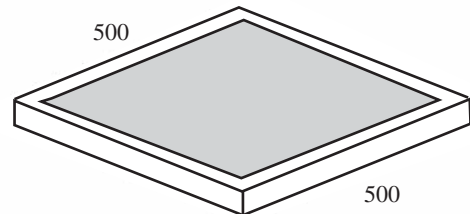

**Non slip**

#### Hand-float finish

**500 x 500 x 50**  
**460 x 460 x 40**

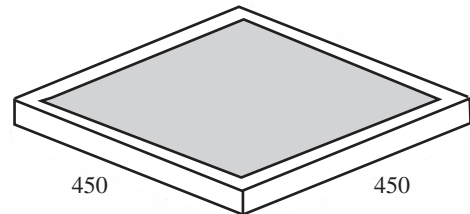

**Hand float finish**

## Grass Blocks

498 x 498mm sq. x 112

Soil to fill = 0.024 m<sup>3</sup> per sq.

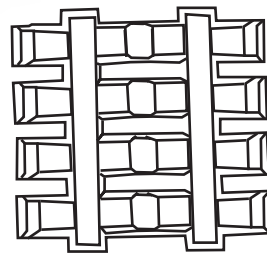

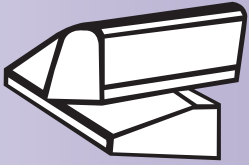

## Sills A

**S1 245 x 100**

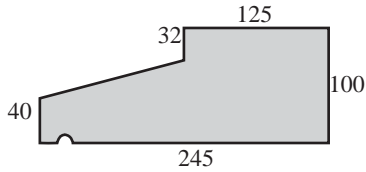

**S3 245 x 135**

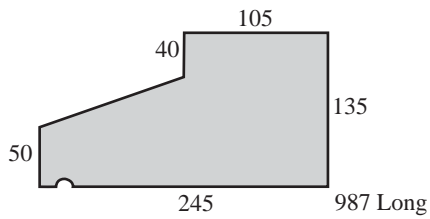

**S5 245 x 100**

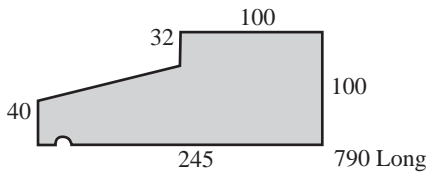

**S7 180 x 75**

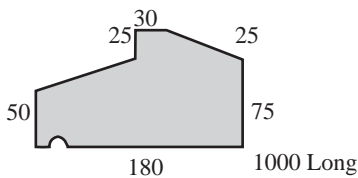

**S9 530 x 235**

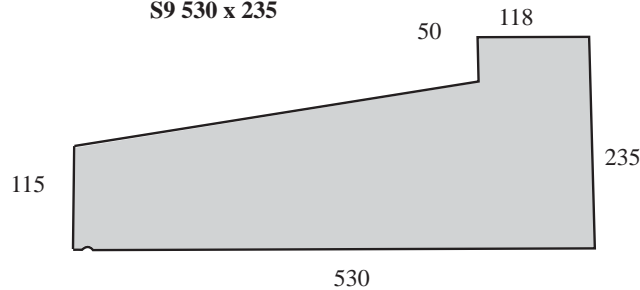

**S10 650 x 150**

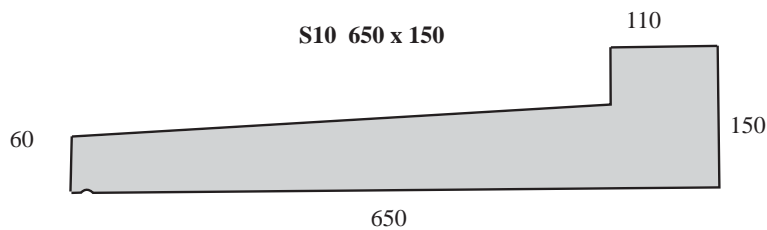

**S2 220 x 90**

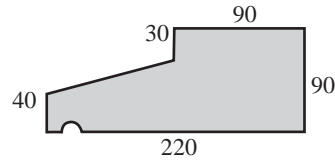

**S4 295 x 85**

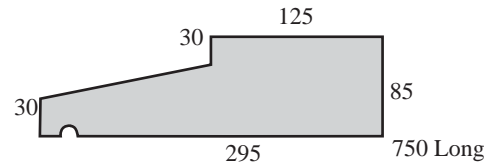

**S6 500 x 155**

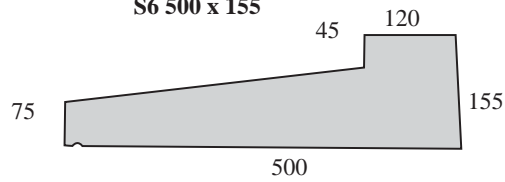

**S8 365 x 80**

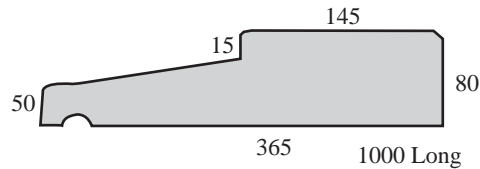

**BOOK LEAF CILL**

NOTE: Sills will only be manufactured on request

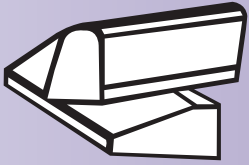

# KALVIS CC

PRECAST CONCRETE SPECIALIST

## Sills B

**S11 135 x 100**

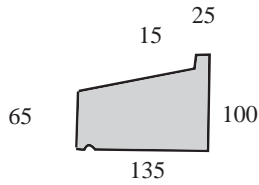

**S12 250 x 145**

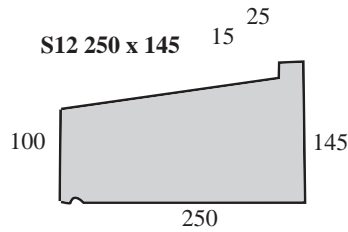

**S13 220 x 110**

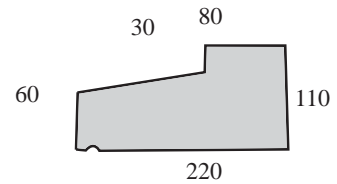

**S14 215 x 135**

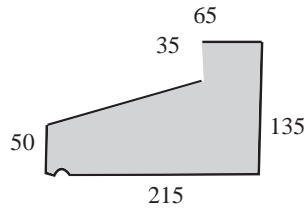

**S15 185 x 75**

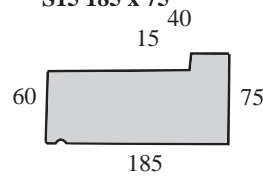

**S16 245 x 100**

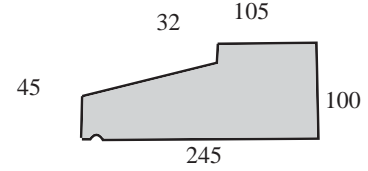

**S18 185 x 70**

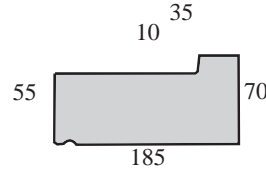

**S19 165 x 140**

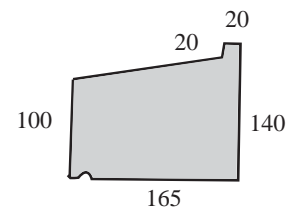

**S17 155 x 193**

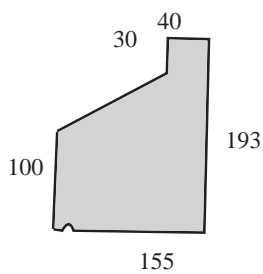

**S20 165 x 110**

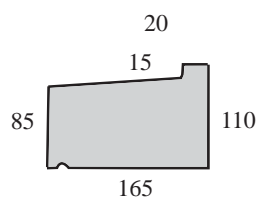

**S21 150 x 53**

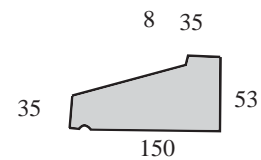

**S22 280 x 100**

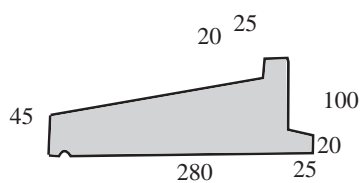

**S23 255 x 100**

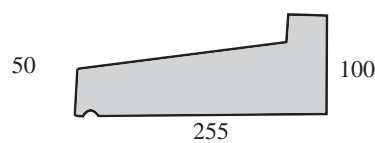

**S24 265 x 100**

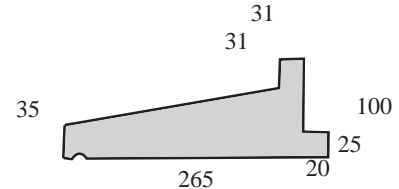

**S25 165 x 90**

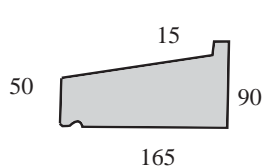

**S26 215 x 115**

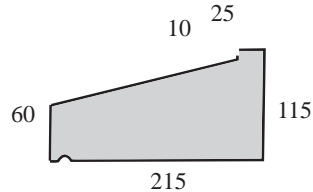

**S27 210 x 75**

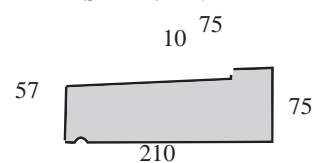

NOTE: Sills will only be manufactured on request

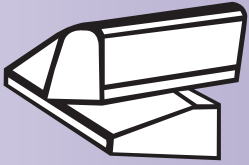

## Sills C

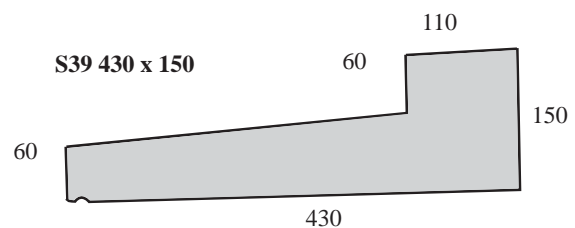
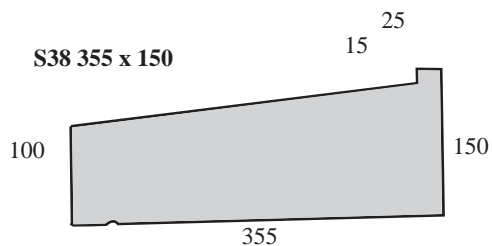
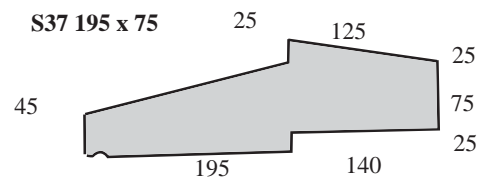
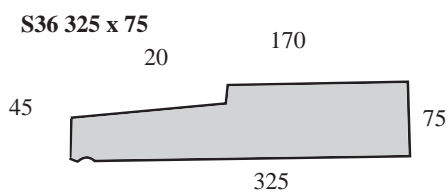
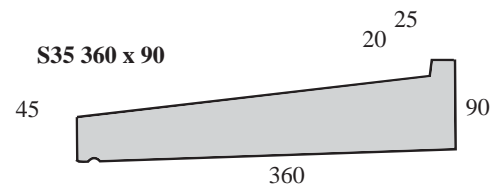
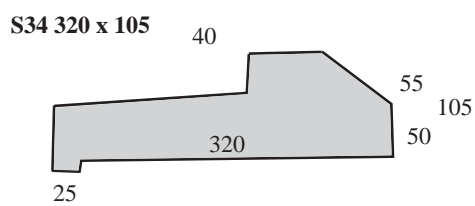
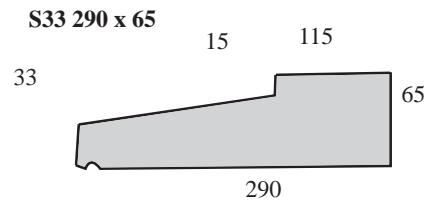
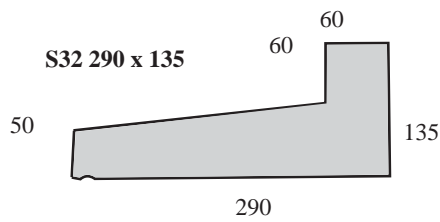
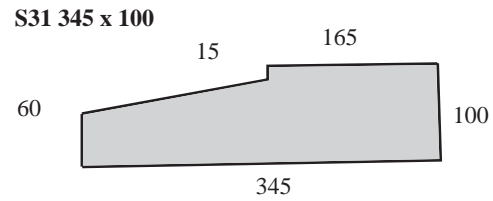
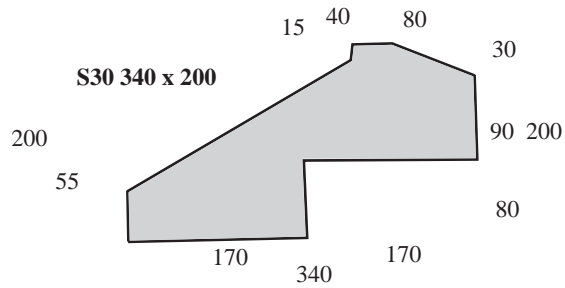
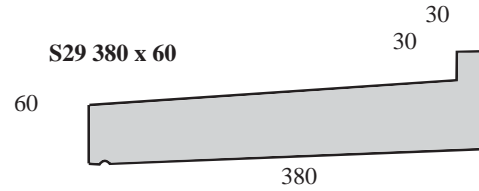
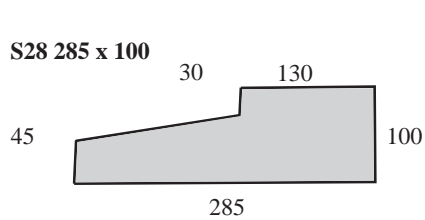

NOTE: Sills will only be manufactured on request

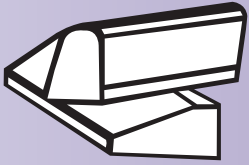

## Gulleys

Storm Water Gully Top

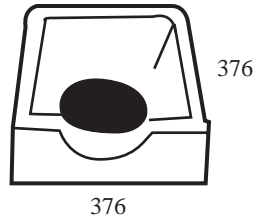

Gully Top

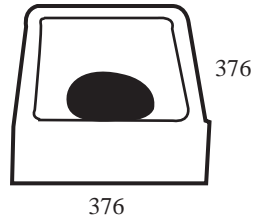

## Septic Tank

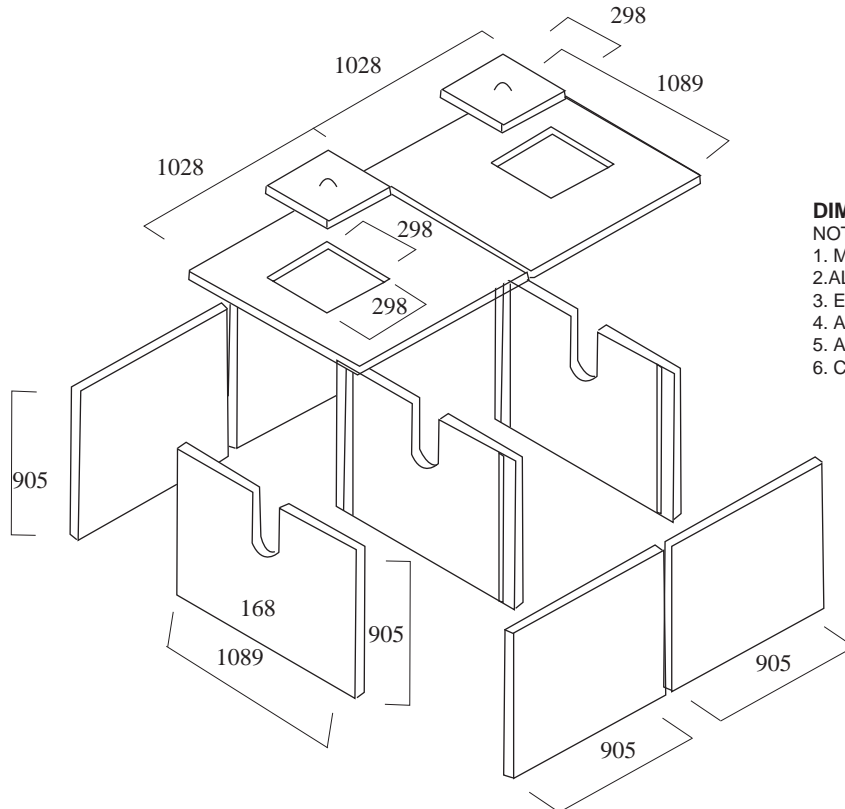

**DIMENSIONS:**

**NOTE:**

1. MASS: 998KG
2. ALL SECTIONS 50mm THICK
3. EFFECTIVE INTERNAL DIMENSIONS: 905 x 905 x 915
4. ALL SECTIONS LIGHTLY RE-INFORCED
5. ADDITIONAL COMPARTMENTS
6. CAPACITY, 620 LITRES /COMPARTMENT

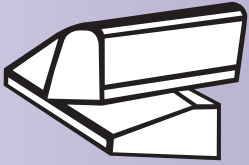

**KALVIS CC**  
PRECAST CONCRETE SPECIALIST

Approved manufacturer of Reinforced Earth products in KZN

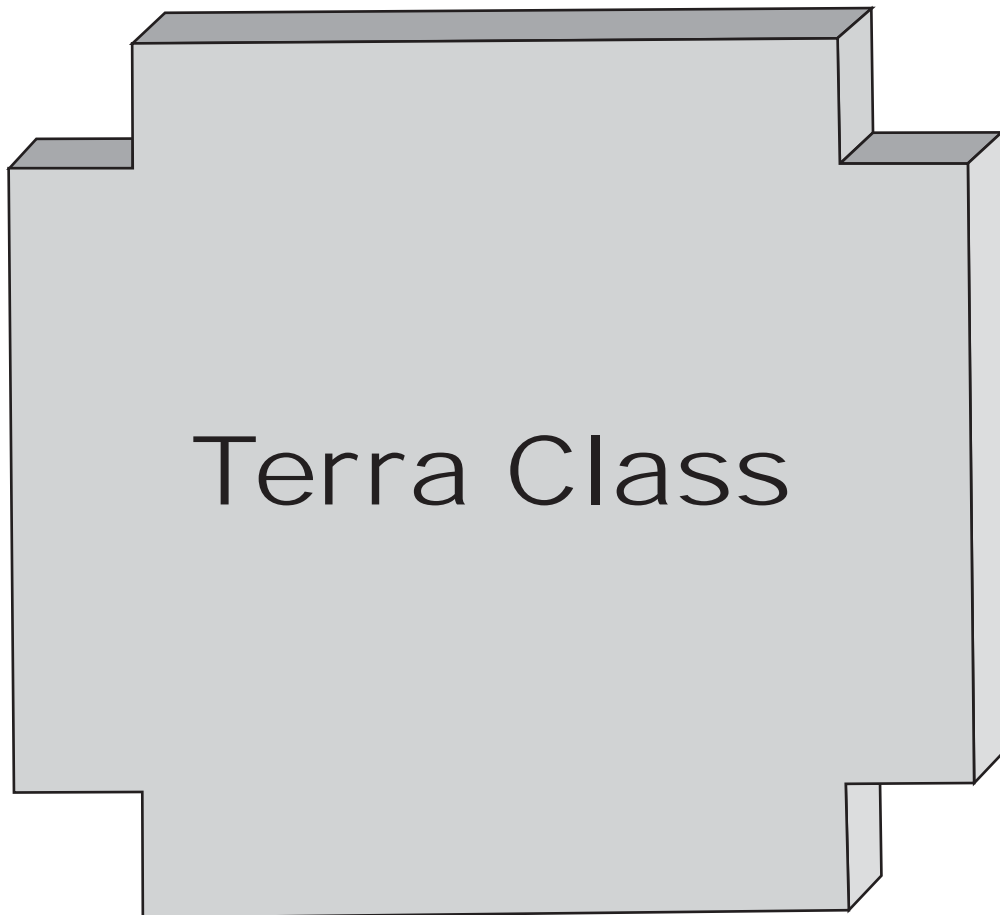

# Precast Panels

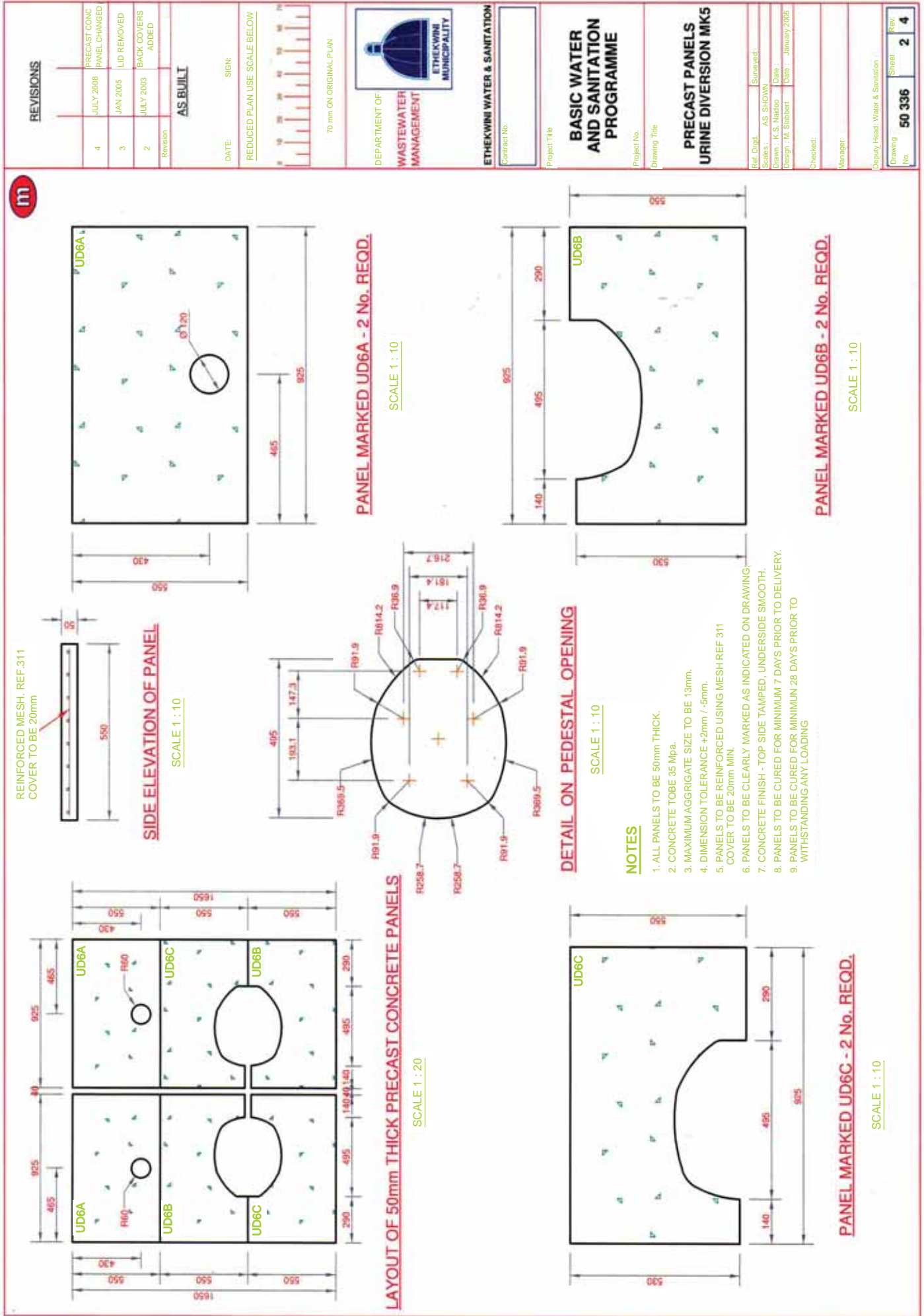

## REVISIONS

Revision	Date	Description
4	JULY 2008	PRECAST CONC PANEL CHANGED
3	JAN 2005	LID REMOVED
2	JULY 2003	BACK COVERS ADDED
<b>AS BUILT</b>		

DATE: \_\_\_\_\_ SIGN: \_\_\_\_\_

REDUCED PLAN USE SCALE BELOW

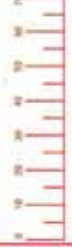

70 mm ON ORIGINAL PLAN



DEPARTMENT OF WASTEWATER MANAGEMENT

ETHEKWINI WATER & SANITATION

Contract No. \_\_\_\_\_

Project Title

**BASIC WATER AND SANITATION PROGRAMME**

Project No. \_\_\_\_\_

Drawing Title

**PRECAST PANELS URINE DIVERSION MKS**

Ref. Dred. \_\_\_\_\_

Scale: AS SHOWN

Drawn: K.S. Ndlovu

Date: \_\_\_\_\_

Design: M. Sibbert

Date: January 2005

Checked: \_\_\_\_\_

Manager: \_\_\_\_\_

Deputy Head: Water & Sanitation

Drawing No.	50 336	Sheet	2	Rev.	4
-------------	--------	-------	---	------	---

## NOTES

1. ALL PANELS TO BE 50mm THICK.
2. CONCRETE TO BE 35 Mpa.
3. MAXIMUM AGGREGATE SIZE TO BE 13mm.
4. DIMENSION TOLERANCE +2mm / -5mm.
5. PANELS TO BE REINFORCED USING MESH REF 311 COVER TO BE 20mm MIN.
6. PANELS TO BE CLEARLY MARKED AS INDICATED ON DRAWING.
7. CONCRETE FINISH - TOP SIDE TAMPED, UNDERSIDE SMOOTH.
8. PANELS TO BE CURED FOR MINIMUM 7 DAYS PRIOR TO DELIVERY.
9. PANELS TO BE CURED FOR MINIMUM 28 DAYS PRIOR TO WITHSTANDING ANY LOADING

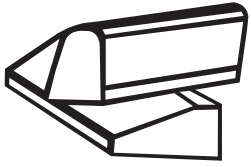

**KALVIScc**  
PRECAST CONCRETE SPECIALIST



## **DURBAN BEACH FRONT (KERBS)**





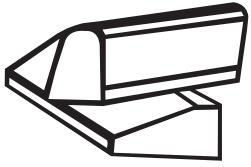

**KALVIScc**  
PRECAST CONCRETE SPECIALIST

## Warwick (Barrier kerbs & reinforced earth)



## M41 (KERBS)



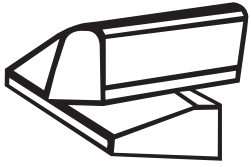

**KALVIScc**  
PRECAST CONCRETE SPECIALIST

## Town Gardens (Seating)

